

FILE: TH-1 Antenna and Base

SHEET: Projected Views

SHEET 1 OF 4  
PAPER SIZE: A  
SCALE: 1:2  
DO NOT SCALE DRAWING

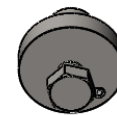
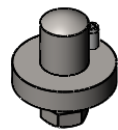
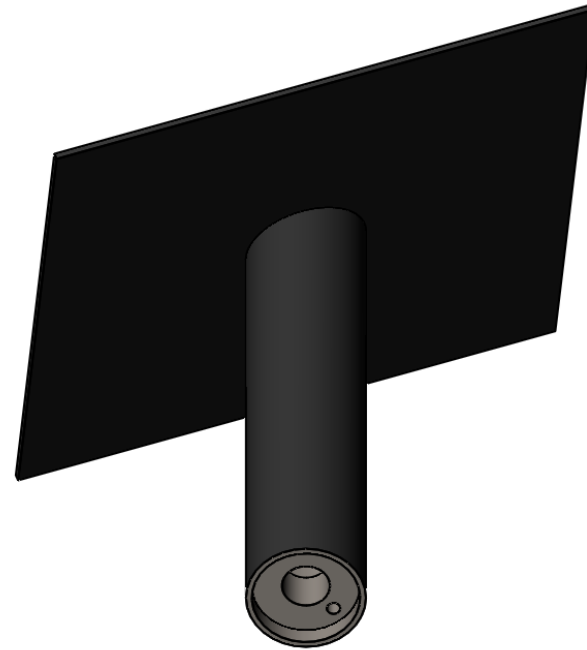
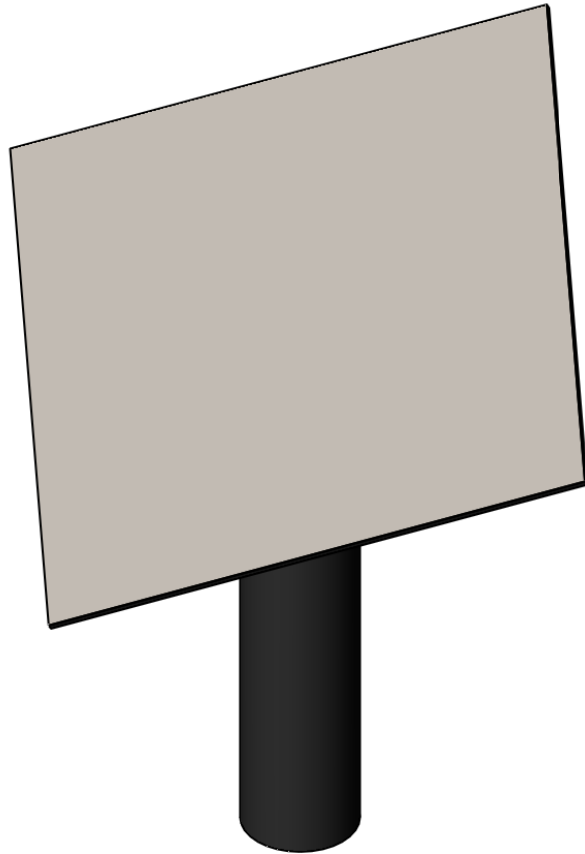

FILE: TH-1 Antenna and Base  
SHEET: Elevation & Section Views

SHEET 2 OF 4  
PAPER SIZE: A  
SCALE: 1:2  
DO NOT SCALE DRAWING

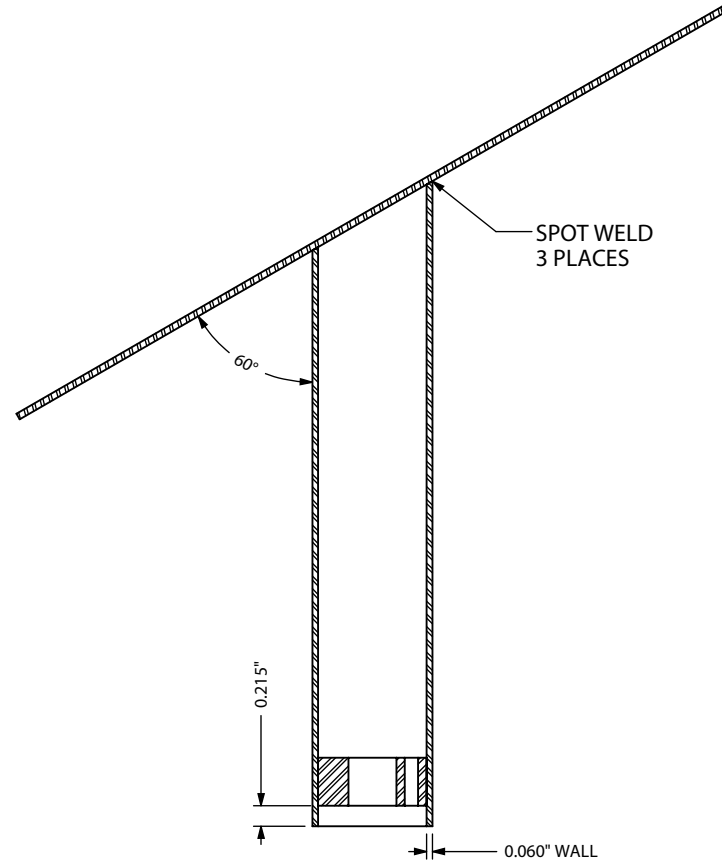
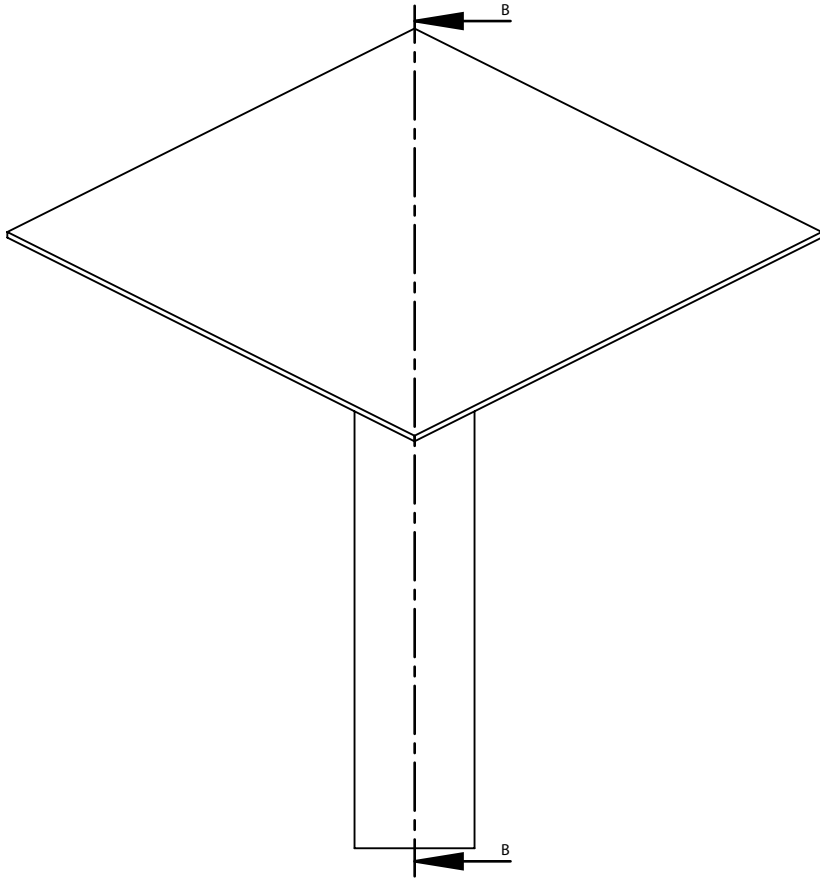

SECTION B-B

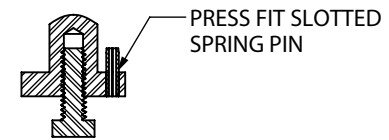
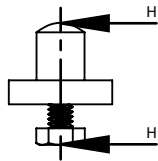

SECTION H-H

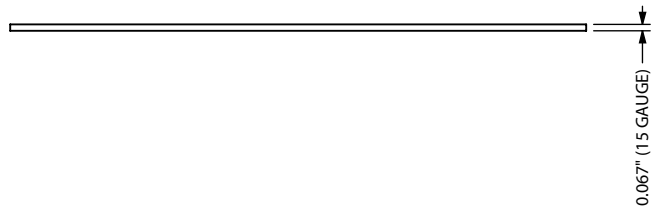
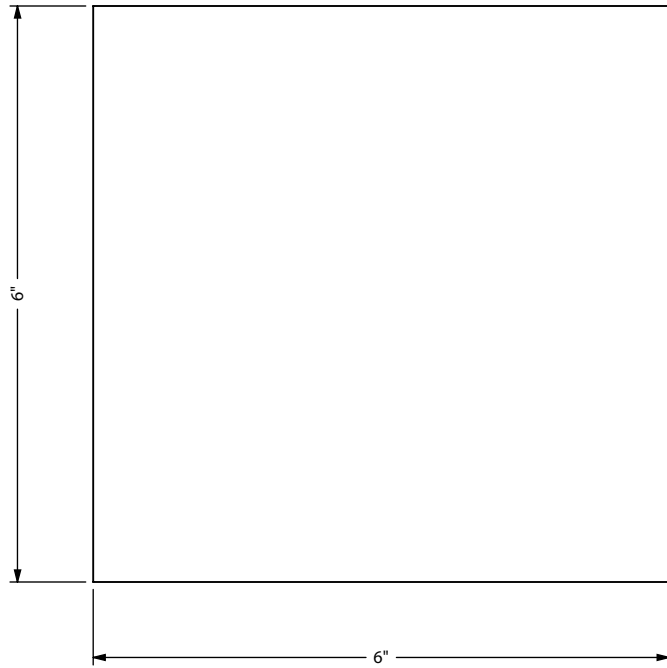

STEEL ANTENNA PLATE  
SCALE 1:2

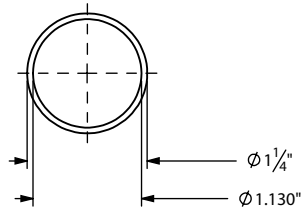
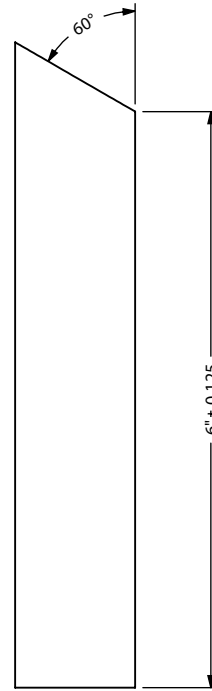

STEEL ANTENNA TUBE  
SCALE 1:2

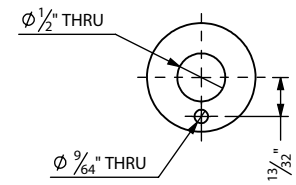
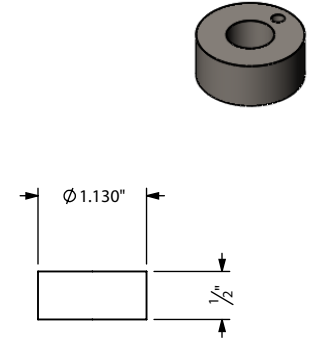

STEEL ANTENNA TUBE BASE  
SCALE 1:2

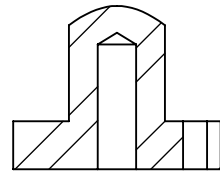
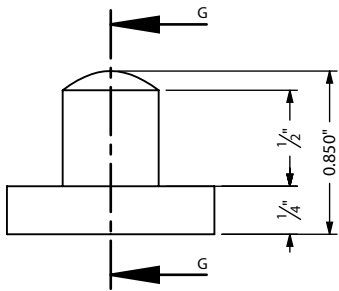
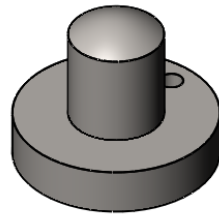
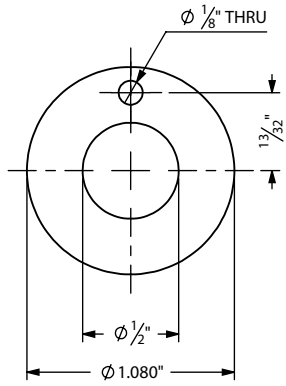

SECTION G-G

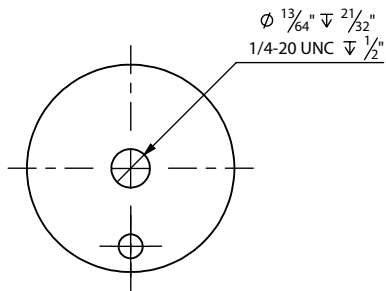

STEEL BASE  
SCALE 1:1

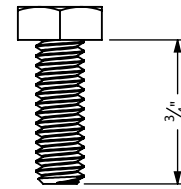
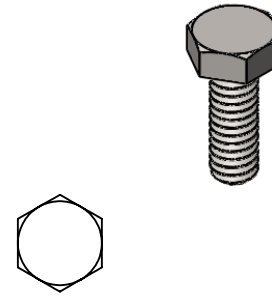

1/4-20 STEEL HEX HEAD MACHINE SCREW  
SCALE 1:1

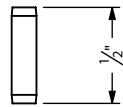

1/8" STEEL SLOTTED SPRING PIN  
SCALE 1:1